

ERFD-MSMA4A-05GLSZH

D Code M12 Male 0° Straight, D Code M12 Male 90° Angled, 4 Pin, LSZH, 05 Meters

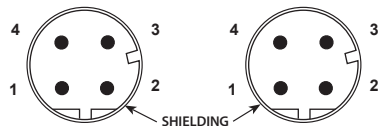
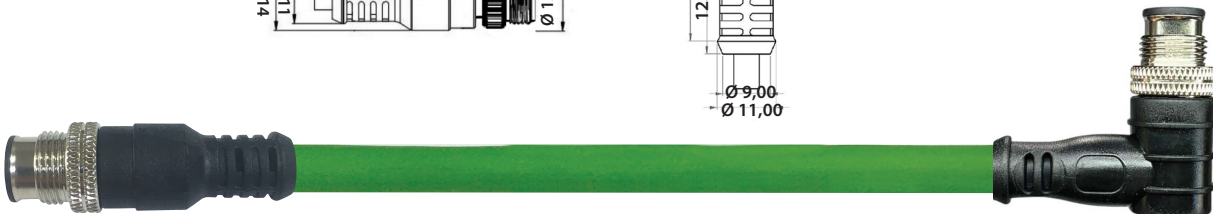
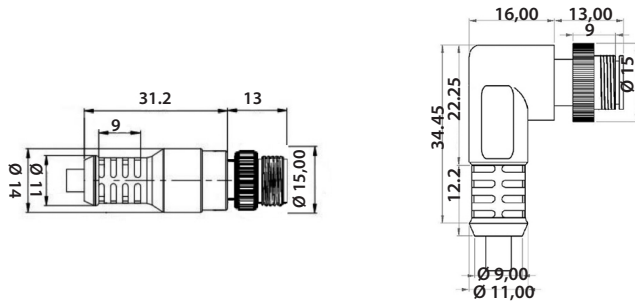

Technical Data

Standard	IEC 61076	Contact Carriers Material	CU / AU
Series	Male, Straight,Angled	Contact Material	Copper Alloy, Gold-Plated
Pin	Cu / Au	Metal of Nut	Copper Alloy with Nickel Plated
Rated Current	1,5 A max	Seal	Silicone
Rated Voltage	60V max.	Cable Jacket Material	LSZH
Insulation Resistance	≥100MΩ	Color	Optional
Contact Resistance	≤ -5mΩ	Shielding	Optional
Ambient Temperature	-25 ~ +85°C	Mechanical Life	> 100 Mating Cycles
IP Class	IP67	—	—

ARTICLE NO	TYPE	ANGLE	PIN	CABLE LENGTH	COLOR	CABLE TYPE	CABLE SECTION
ERFD-MSMA4A-05GLSZH	M - M	S - A	4 PIN	5 METERS	GREEN	LSZH	4 x 1 x AWG26