

ERFD-FAMA4A-01,5GPUR

D Code M12 Female 90° Angled, D Code M12 Male 90° Angled, 4 Pin, PUR, 01,5 Meters

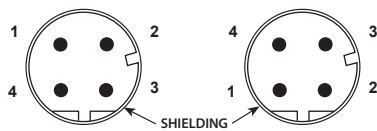
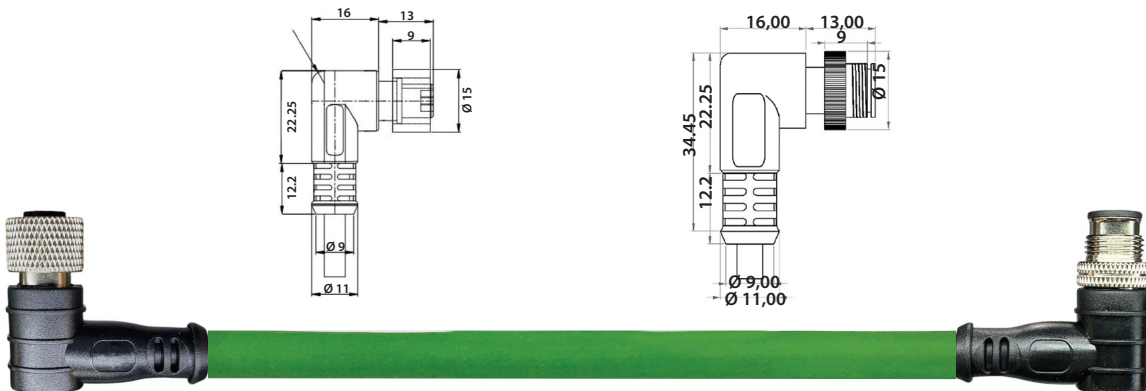

Technical Data

Standard	IEC 61076	Contact Carriers Material	CU / AU
Series	Male, Female, Angled	Contact Material	Copper Alloy, Gold-Plated
Pin	Cu / Au	Metal of Nut	Copper Alloy with Nickel Plated
Rated Current	1,5 A max	Seal	Silicone
Rated Voltage	60V max.	Cable Jacket Material	PUR
Insulation Resistance	≥100MΩ	Color	Optional
Contact Resistance	≤ -5mΩ	Shielding	Optional
Ambient Temperature	-25 ~ +85°C	Mechanical Life	> 100 Mating Cycles
IP Class	IP67	—	—

ARTICLE NO	TYPE	ANGLE	PIN	CABLE LENGTH	COLOR	CABLE TYPE	CABLE SECTION
ERFD-FAMA4A-01,5GPUR	M - F	A - A	4 PIN	1,5 METERS	GREEN	PUR	4 x 1 x AWG26