

ERFD-FAFA4A-01GLSZH

D Code M12 Female 90° Angled, D Code M12 Female 90° Angled, 4 Pin, LSZH, 01 Meters

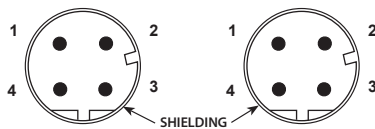
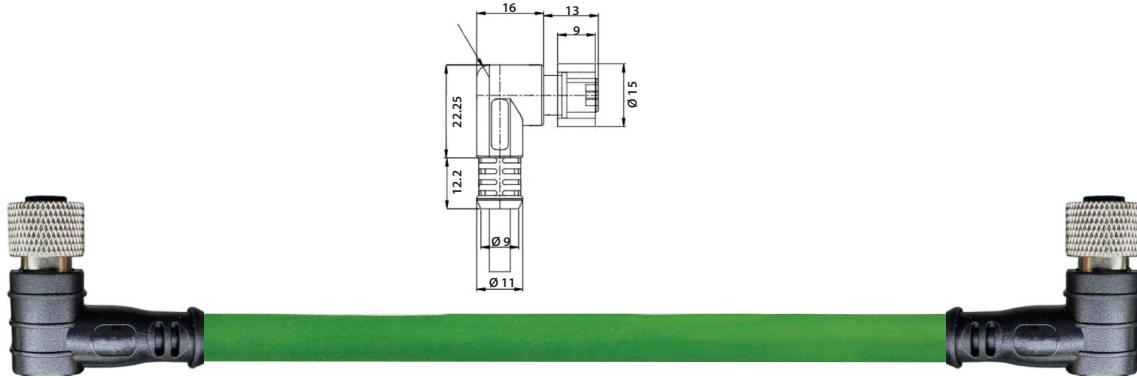

Technical Data

Standard	IEC 61076	Contact Carriers Material	CU / AU
Series	Female , Angled	Contact Material	Copper Alloy, Gold-Plated
Pin	Cu / Au	Metal of Nut	Copper Alloy with Nickel Plated
Rated Current	1,5 A max	Seal	Silicone
Rated Voltage	60V max.	Cable Jacket Material	LSZH
Insulation Resistance	≥100MΩ	Color	Optional
Contact Resistance	≤ -5mΩ	Shielding	Optional
Ambient Temperature	-25 ~ +85°C	Mechanical Life	> 100 Mating Cycles
IP Class	IP67	—	—

ARTICLE NO	TYPE	ANGLE	PIN	CABLE LENGTH	COLOR	CABLE TYPE	CABLE SECTION
ERFD-FAFA4A-01GLSZH	F - F	A - A	4 PIN	1 METERS	GREEN	LSZH	4 x 1 x AWG26