

ERF8-FA4C-25BPVC

M8 Female, 0° Angled, 4 Pin, PVC,
25 Meters, 4x0,22 mm²

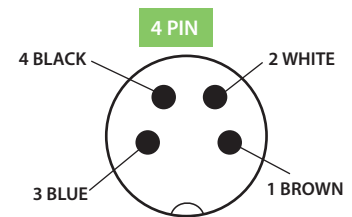
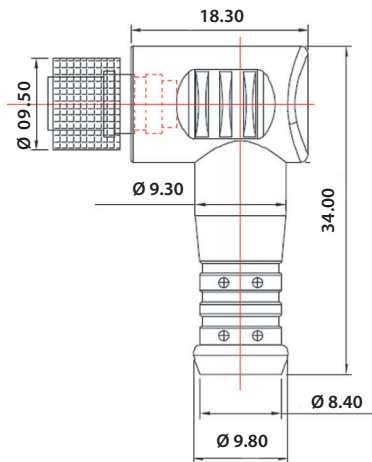

Technical Data

Standard	IEC 61076	Contact Carriers Material	PU / PA
Series	M8, Female, Angled	Contact Material	Copper Alloy, Gold-Plated
Number of Pins	04 Pin	Metal of Nut	Copper Alloy with Nickel Plated
Rated Current	3A max.	Seal	Silicone
Rated Voltage	60V max.	Cable Jacket Material	PVC
Insulation Resistance	≥100MΩ	Color	Optional
Contact Resistance	≤ -5mΩ	Shielding	Optional
Ambient Temperature	-25 ~ +75°C	Mechanical Life	> 100 Mating Cycles
IP Class	IP67	—	—

ARTICLE NO	TYPE	ANGLE	PIN	CABLE LENGTH	COLOR	CABLE TYPE	CABLE SECTION
ERF8-FA4C-25BPVC	F - FEMALE	A - ANGLED	4 PIN	25 METERS	BLACK	PVC	4 x 0,22 mm ²