

ERF8-FA3B-05BPUR

M8 Female, 0° Angled, 3 Pin, PUR,
05 Meters, 3x0,34 mm²

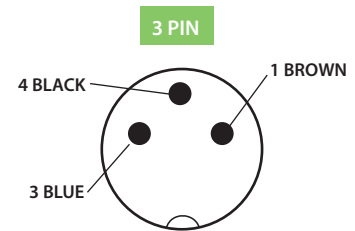
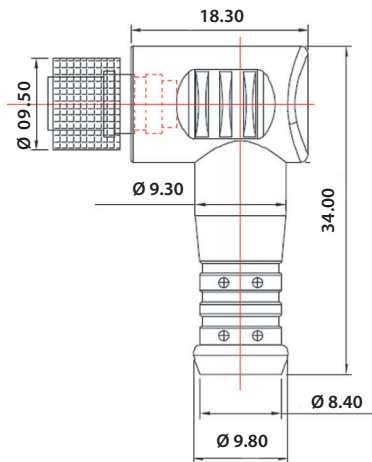

Technical Data

Standard	IEC 61076	Contact Carriers Material	PU / PA
Series	M8, Female, Angled	Contact Material	Copper Alloy, Gold-Plated
Number of Pins	03 Pin	Metal of Nut	Copper Alloy with Nickel Plated
Rated Current	3A max.	Seal	Silicone
Rated Voltage	60V max.	Cable Jacket Material	PUR
Insulation Resistance	≥100MΩ	Color	Optional
Contact Resistance	≤ -5mΩ	Shielding	Optional
Ambient Temperature	-25 ~ +75°C	Mechanical Life	> 100 Mating Cycles
IP Class	IP67	—	—

ARTICLE NO	TYPE	ANGLE	PIN	CABLE LENGTH	COLOR	CABLE TYPE	CABLE SECTION
ERF8-FA3B-05BPUR	F - FEMALE	A - ANGLED	3 PIN	5 METERS	BLACK	PUR	3 x 0,34 mm ²